

Die Scheinwerfer der Red Line Serie verdanken ihren Namen dem neuen Design und dem optisch ansprechenden roten Rand im äußeren Bereich der Linse. Die verbesserte Linsen Optik sorgt für eine optimale und saubere Ausleuchtung. Verfügbar sind 3 Formen mit jeweils 3 Größen.

- 2 Jahre Garantie
- Hochleistungs LEDs mit widerstandsfähiger Polycarbonatlinse



LED SCHEINWERFER - RED LINE SERIE QUADRATISCH SPEZIFIKATIONEN

ECE-R10

Spannungsbereich:	12-24V
Lichtleistung:	960-3.840lm (840-3.300lm gemessen)
Wasserdicht:	IP67
Montage:	Schraubmontage
Zulassungen:	ECE-R10
Gehäuse:	Aluminium
Leuchtbild:	Flood

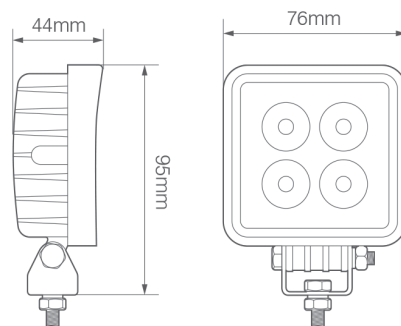



LARL7612BM



LARL10527BM



LARL11048BM

Artikel	Beschreibung	Abmessungen	Lumen
 LARL7612BM	LED Scheinwerfer Quadratisch	76 x 95 x 44mm	960lm (840lm gemessen)
 LARL10527BM	LED Scheinwerfer Quadratisch	105 x 135 x 55mm	2.160lm (1.760lm gemessen)
 LARL11048BM	LED Scheinwerfer Quadratisch	110 x 137 x 70mm	3.840lm (3.300lm gemessen)



LED SCHEINWERFER - RED LINE SERIE RECHTECKIG SPEZIFIKATIONEN

ECE-R10

Spannungsbereich:	12-24V
Lichtleistung:	720-3.600lm (700-3.000lm gemessen)
Wasserdicht:	IP67
Montage:	Schraubmontage
Zulassungen:	ECE-R10
Gehäuse:	Aluminium
Leuchtbild:	Flood

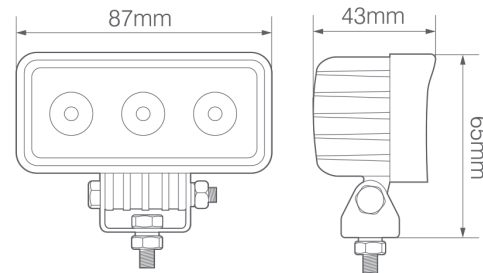



LARL8809BM



LARL11024BM



LARL15545BM

Artikel	Beschreibung	Abmessungen	Lumen
 LARL8809BM	LED Scheinwerfer Rechteckig	87 x 65 x 43mm	720lm (700lm gemessen)
 LARL11024BM	LED Scheinwerfer Rechteckig	114 x 96 x 56mm	1.920lm (1.430lm gemessen)
 LARL15545BM	LED Scheinwerfer Rechteckig	158 x 120 x 70mm	3.840lm (3.300lm gemessen)

LED SCHEINWERFER - RED LINE SERIE OVAL SPEZIFIKATIONEN

ECE-R10

Spannungsbereich:	12-24V
Lichtleistung:	720-3.120lm (700-3.120lm gemessen)
Wasserdicht:	IP67
Montage:	Schraubmontage
Zulassungen:	ECE-R10
Gehäuse:	Aluminium
Leuchtbild:	Flood

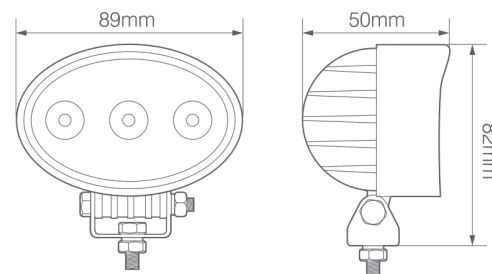

LED SCHEINWERFER

RED LINE SERIE





LARL9809BM



LARL14024BM



LARL14539BM

Artikel	Beschreibung	Abmessungen	Lumen
 LARL9809BM	LED Scheinwerfer Oval	89 x 82 x 50mm	720lm (700lm gemessen)
 LARL14024BM	LED Scheinwerfer Oval	142 x 110 x 70mm	1.920lm (1.640lm gemessen)
 LARL14539BM	LED Scheinwerfer Oval	146 x 126 x 76mm	3.120lm (2.900lm gemessen)

