

Die Rundumleuchte der Serie Atlas vereint hohe Performance, die durch IP69K und **bestmögliche EMV Zulassungen** gegeben ist, mit einem optisch ansprechendem Design. Zusätzlich dazu wurde die Wärmeableitung der LEDs optimiert um die Lebensdauer zu verlängern und die Funktionalität unter schwierigen Bedingungen zu gewährleisten.

- 3 Jahre Garantie
- Gelb: Rotation
- Blau: Einzelblitz
- 8 Hochleistungs LEDs



LED RUNDUMLEUCHTEN - SERIE ATLAS SPEZIFIKATIONEN

ECE-R65

ECE-R10

CISPR 25

Spannungsbereich:	9-32V
Wasserdicht:	IP69K (ISO 20653)
Montage:	Fix-, Magnet- & flexible Rohrmontage
Zulassungen:	ECE-R65, ECE-R10, CISPR25 Level 5
Gehäuse:	Kunststoff
Abmessungen:	ø 140 x 82mm (Fixmontage)

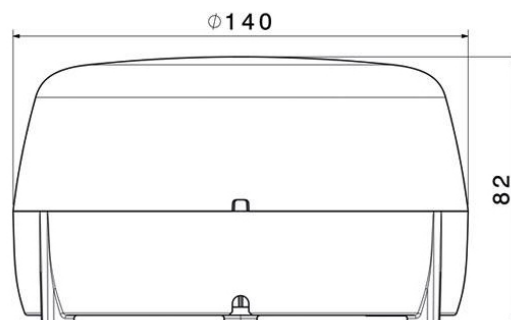







Magnetmontage ø 140 x 94mm



Flexible Rohrmontage, ø 140 x 142mm



BESTELLINFORMATIONEN

Artikel		Beschreibung
	VG2120L45305 ●	LED Rundumleuchte, Rotation, gelbe Linse, 9-32V, Fixmontage
	VG2120LV5305 ●	LED Rundumleuchte, Rotation, gelbe Linse, 9-32V, Magnetmontage
	VG2120L75305 ●	LED Rundumleuchte, Rotation, gelbe Linse, 9-32V, flexible Rohrmontage
	VG2125L45305 ●	LED Rundumleuchte, Einzelblitz, blaue Linse, 9-32V, Fixmontage
	VG2125LV5305 ●	LED Rundumleuchte, Einzelblitz, blaue Linse, 9-32V, Magnetmontage
	VG2125L75305 ●	LED Rundumleuchte, Einzelblitz, blaue Linse, 9-32V, flexible Rohrmontage